



PO Nox 338 \* Spring Hill, TN 37174  
Toll Free: 1-866-753-2655 \* Fax: 931-486-0316  
www.pioneerindustrialdoors.com

## **Assembly Instructions Vertical Vinyl Curtain Door “Face Mount with Chain Hoist Operator”**

*We have pre-assembled the roller, valence, and bracketry components for your Door. This should dramatically simplify the installation procedure. While the installation is very straightforward, please note the following details.*

### **System Overview:**

Your Vinyl Vertical Curtain Door is a high quality, high performance flexible door system based on proven components and our many years of experience in the vinyl partition fabrication business. We are confident that it will bring you and/or your customers years of reliable and trouble-free service.

Your specific system is a vinyl motorized roll-up curtain door with face-mount bracketry and a chain hoist operator. The “back-to-back” mounting dimension for your vertical extrusions will be the door opening width plus approximately 8” (eight inches). The vertical extrusions are cut to the same height as your stated door opening, which will place the entire motorized roll, upper bracketry, and valence box above the door header.

### **Unpacking and Inspection:**

Please unpack your systems carefully and notify the factory immediately if there are any shortages or if any items have been damaged during transit. Your kit(s) should have all of the necessary hardware and components for a complete installation with the following exceptions (installer-provided hardware):

1. Mounting hardware for securing the custom extrusions, bracketry and chain hoist operator to the building fascia.

# **WARNING!**

**This product is a non-counterbalanced manually operated overhead door.**

**Care and caution should be exercised during the installation and general operation of this door.**

**Failure to control the downward speed of the door can cause personal injury and damage to the door mechanism.**

## System Assembly:

Site Preparation:

**It is imperative that the heavy duty bracketry and chain hoist operator for your door assembly is mounted to a flat and uniform surface. Mounting the door or operator to an uneven surface can cause the bracketry to bend and distort, causing improper door operation and premature failure.**

**Sections of vinyl stripping are in place to stop the vinyl door from unrolling during installation. DO NOT remove these straps until after the drive chain has been installed!**

Lay the upper box section of your door on a flat surface and measure the “back-to-back” angle bracket dimension for your specific door as shown in the following photo (Photo 1). In this specific case the dimension is 108”.

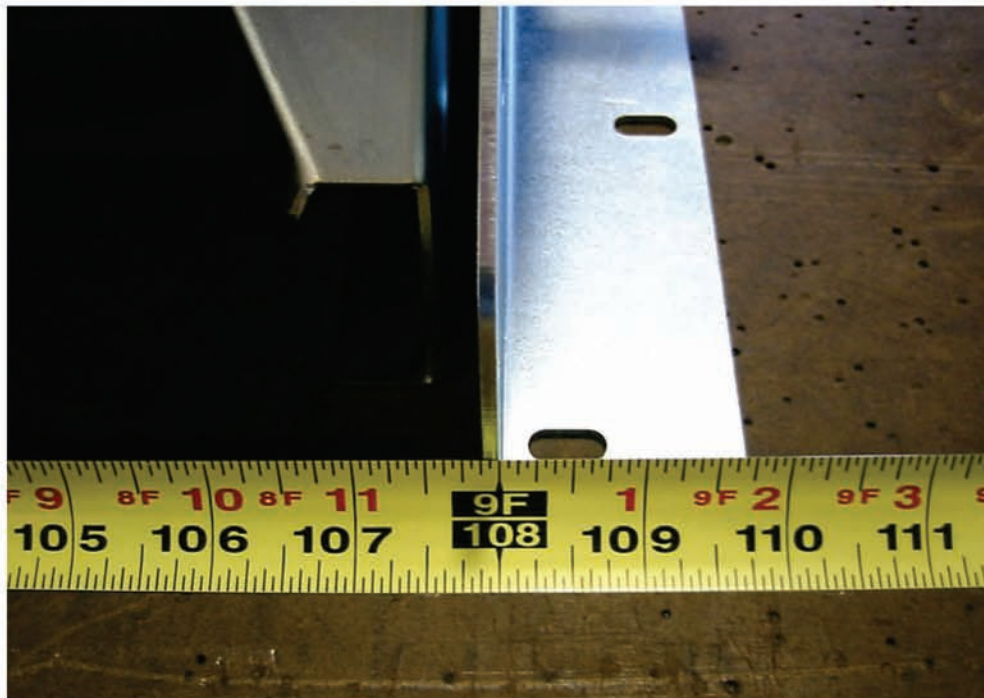

**Photo #1**

(Angle Bracket Back-to-Back Dimension)

Divide this number by 2 (54” in this specific case). This will be your “A” dimension.

Remove the two lower corner Phillips fasteners that secure the vinyl valence (cover) to the box and carefully roll back the corners to expose the brackets and roller tube assembly. This will make future installation operations substantially easier. Reinstall the Phillips fasteners in their nuts and tighten snugly. This will hold the nut locations in the extruded bars and help to avoid losing the fasteners.

Lay one of your custom vertical extrusions (side rails) on a flat surface and measure the overall length of the extrusion as shown in the following photo (Photo 2). In this specific case the dimension is 107.75” (107 <sup>3</sup>/<sub>4</sub>”).



**Photo #2**

(Extrusion Overall Length Dimension)

Subtract .75" ( $\frac{3}{4}$ ") from this dimension (107" in this specific case). This will be your "B" dimension.

Make a mark on your building fascia "A" inches to the right from the top centerline of your door opening. This mark will correspond to the approximate edge location for your angle bracket. Repeat this process to the left of your opening centerline.

Make a horizontal line on your building fascia to the left and right of your opening at "B" inches from the ground surface. This line will correspond to the bottom edge of your angle brackets.

The angle brackets have a footprint of approximately 2" to each side of the "A" mark and 8" above the "B" line as shown in the following diagram (Diagram 1). Make sure that this area is smooth, flat, and even.

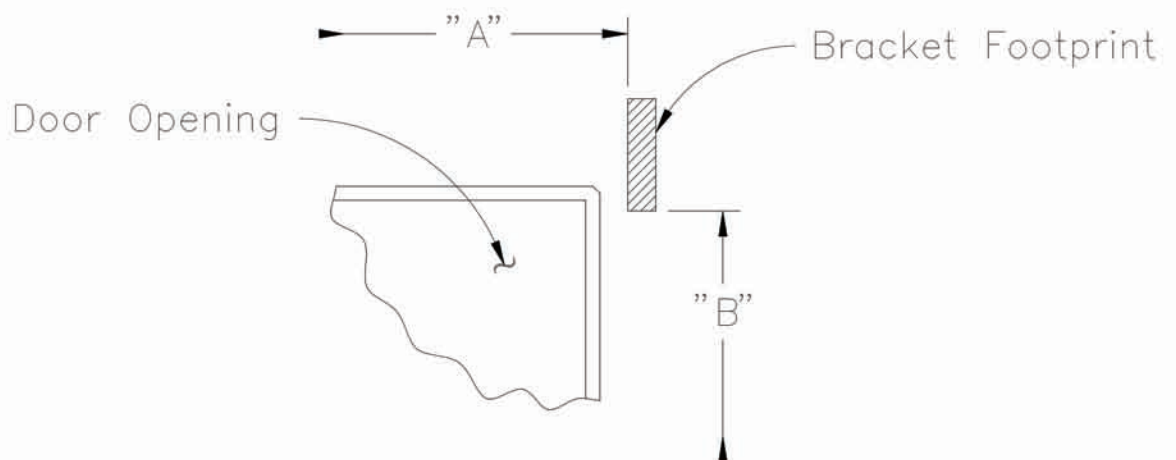

**Diagram #1**

(Angle Bracket Mounting Footprint)

## Upper Box Mounting:

The Upper Box Section of your door is best installed by two people with individual ladders, one person and a scissors lift, or some other mechanism for raising and holding the box in position while it is being secured to the building fascia. The box section should not be bent or distorted while it is being mounted.

Raise the box section to the elevation of your opening header and use the “A” marks to center it about your door opening. Carefully adjust the elevation of the box ends until the bottoms of the angle brackets are in alignment with the “B” lines. Secure the left bracket to your building fascia using one fastener and washer as shown in the following photo (Photo 3). The specific fastener type will be a function of your building material, but each fastener should be approximately ¼” in diameter and capable of handling at least 100lbs of shear and pull force.

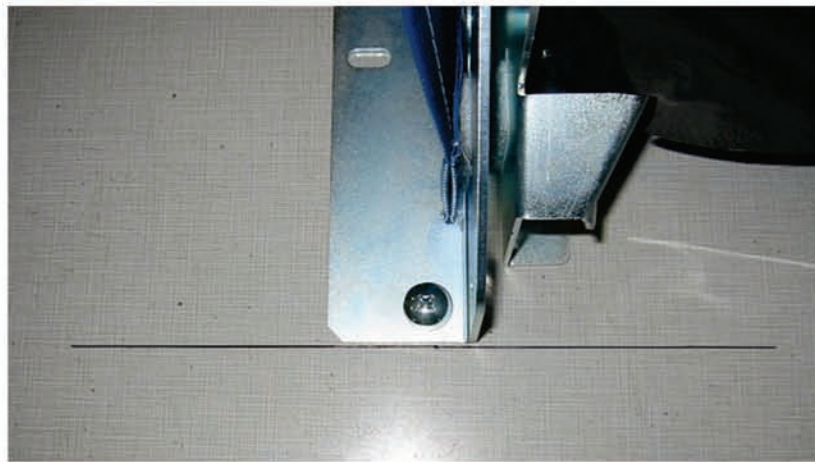

**Photo #3**

(Angle Bracket Alignment and Mounting)

Repeat this procedure on the right bracket. Double check the alignment of the door brackets and ensure that the box structure is not bent or distorted. Install the remaining four fasteners and washers in the angle brackets.

## Vertical Extrusion Mounting:

The Custom Vertical Extrusions will first be secured to the angle brackets on the upper box section, and then secured to the building fascia via “J” brackets.

It is suggested that the galvanized brackets first be mounted to the extrusions. Typically one bracket is mounted approximately 5” in from the bottom end of the vertical extrusion and one bracket is mounted at the mid point. This can be accomplished by laying the extrusion and the bracket on a flat surface, transferring at least one bracket hole location to the extrusion, drilling a .28” diameter hole in the extrusion, and securing the bracket to the extrusion with a ¼-20 x .50 Pan Head Screw, ¼” Flat Washer, and a ¼-20 Hex Nut as shown in the following diagram (Diagram 2). Note that the extrusion must be oriented in such a manner that the “Radius Profile” is **not** adjacent to the building fascia. The extrusions have been marked with a “TR” (Top Right) and “TL” (Top Left) to assist with

the orientation. Be very careful when drilling the Vertical Extrusions as to not damage the EPDM seal strips.

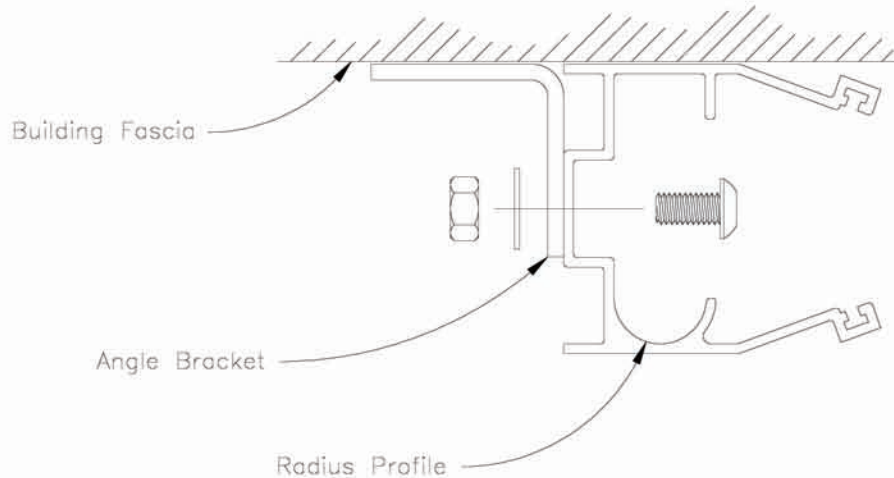

**Diagram #2**

(Extrusion, Bracket and Fascia Orientation)

Locate the left vertical extrusion (marked with a “TL”) and orient it so that the extrusion is on the left side of your opening with the “TL” at the top and facing out. Secure the vertical extrusion to the angle bracket using the supplied ¼-20 Phillips head screw and nut as shown in the following photo (Photo 4)(EPDM seal strips removed for clarity):

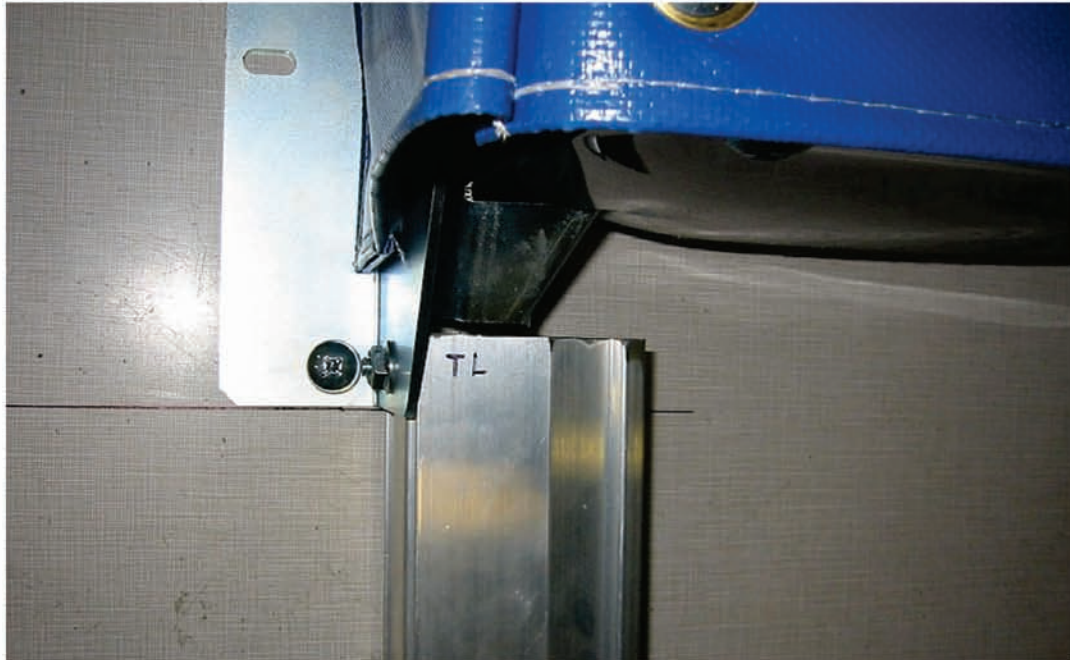

**Photo #4**

(Vertical Extrusion Orientation and Mounting)

Check the transition from the inside of the “Funnel Bracket” to the inside of the vertical extrusion (where the door roller rides). There should be a smooth transition and good alignment between the vertical surfaces. If necessary, remove the Phillips fastener and insert a washer between the aluminum standoff and the angle bracket to obtain this alignment. Reinstall the Phillips fastener.

Use a Carpenters' level or a Plumb Bob to ensure that the left extrusion is completely vertical. Secure the "J" brackets to the building fascia using "best practices" as a function of the building material. The mounting should resemble the following photo (Photo 5):



**Photo #5**  
("J" Bracket Mounting)

Orient the right vertical extrusion (marked with a "TR") so that it is on the right side of your opening with the "TR" at the top of the extrusion facing out. Secure the vertical extrusion to the angle bracket using the supplied 1/4-20 Phillips head screw and nut.

Use a tape measure to ensure that the left and right vertical extrusions are parallel ( $\pm 1/2$ " ) and secure the right extrusion "J" brackets to the building fascia using "best practices" as a function of the building material.

#### Chain Hoist Operator Preparation and Mounting:

**The Chain Hoist Operator will be secured to your building fascia using 1/4" fasteners (bolts, lag screws, studs, etc.). Select fasteners that are not only right for your specific building material, but also that can endure repeated loosening and tightening. It may be necessary to loosen/tighten these fasteners a number of times in order to achieve proper initial chain tension and to later adjust for chain stretch and wear. The use of washers between the heads of the fasteners and the metal bracket on the operator is strongly recommended.**

Locate the Operator Installation Template. Cut along the indicated dotted lines and remove the section of the template that corresponds to the right mounting bracket of the upper box assembly.

Align the template with the right bracket on the upper box assembly and transfer the three hole locations for the 1/4" fasteners to your building fascia. Carefully lift the operator in place and secure it to your building using three 1/4" fasteners. Do not fully tighten the fasteners. Slide the operator "up" until the fasteners are at the bottoms of the mounting slots, and tighten the fasteners snugly enough to stop the operator from sliding back down. Your installation should resemble the following photo (Photo 6):

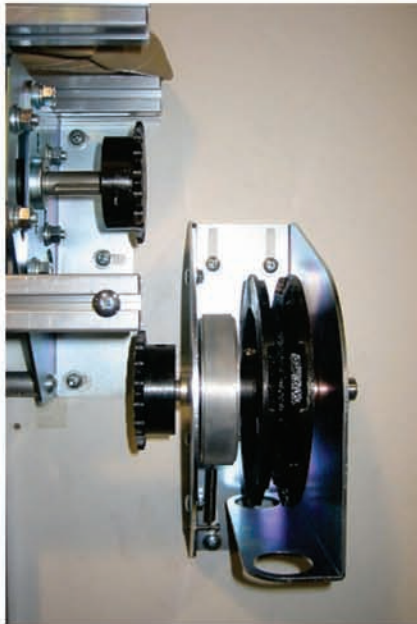
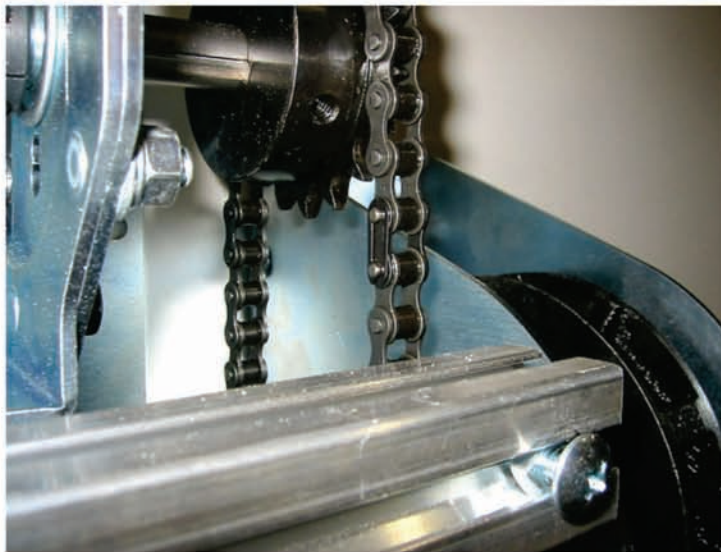

**Photo #6**

(Chain Hoist Operator Mounting)

Check the alignment of the two sprockets. They should be in direct vertical alignment. If not, loosen the set screws on either of the sprockets and adjust its position until it is in line with the other unit.

Locate the #41 chain and install it over the two sprockets. Secure the ends with the included master link as shown in the following photo (Photo 7):

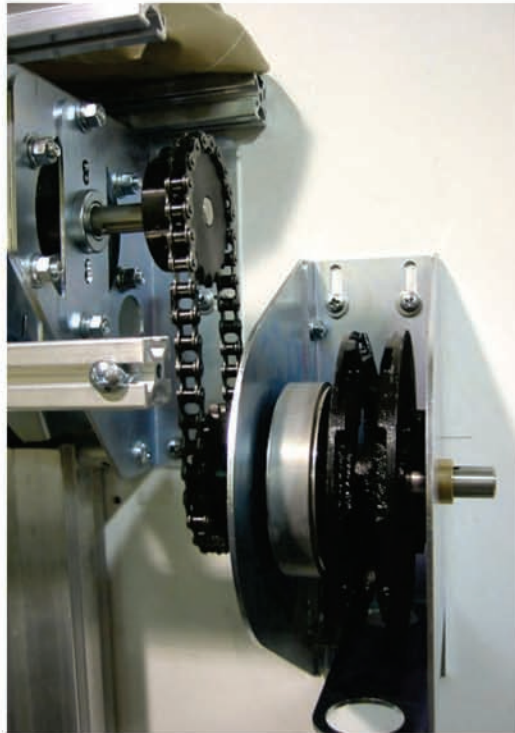

**Photo #7**

(Master Link Installation)

Loosen the three fasteners that secure the chain operator to the building fascia and allow the weight of the operator to establish the tension in the chain. Make sure that the front and rear runs of the chain are “taught” (slightly rotate the chain pocket wheel by hand if necessary). Make sure that the sprockets are still in alignment and tighten the three fasteners. Your assembly should resemble the following photo (Photo 8):





**Photo #8**

(Chain Installation)

Route the Hoist Chain over the Hoist Chain Pocket Wheel as shown in the following photo (Photo 9). Allow about 1' (one foot) of chain to hang off of the back of the wheel (toward the wall) with the rest of the chain hanging off of the front of the wheel.



**Photo #9**

(Hoist Chain and Pocket Wheel)

Install a Stop Bumper on the rear section of chain. The bumper should be installed with the “dome” feature pointing up. Slide the bumper up the chain until it contacts the stop bracket as shown in the following photo (Photo 10). This Stop Bumper will control the “full open”

position of the door. Install a Hitch Pin in the chain link opening directly below the Stop Bumper.



**Photo #10**  
(Upper Stop Bumper Installation)

**Pro Tip:** It is almost impossible to pull a dry chain through the hole in the Stop Bumpers. Apply a little Windex™ or generic household surface cleaner to the chain and it pulls through easily.

**Pro Tip:** The first link of the chain can be pulled through the Stop Bumper with a pair of “needle nose” pliers, or you can use one of the Torque Rods to “pry” the chain through as shown in the following photo (Photo 11):



**Photo #11**  
(Stop Bumper Installation)

Mount the Chain Bracket to the building wall directly below the chain sprocket at a convenient elevation (usually about 4' from the floor) as shown in the following photo (Photo 12):



**Photo #12**  
(Chain Bracket)

Install the other Stop Bumper on the front section of chain. The “dome” on the bumper should be facing “up”. Slide the Bumper onto the chain by a few feet. Do not install the hitch pin at this time.

Join the free ends of the chain by opening one of the links. The chain may be shortened as required to avoid dragging on the ground. Secure the chain to the bracket with a bolt, pin, or other ¼” diameter object as shown in the following photo (Photo 13). Both the front and rear section of chain must be locked into the keeper (retaining bracket) and the chain MUST be properly secured before going to the next assembly steps.



**Photo #13**  
(Securing the Chain)

**The next step involves using the chain hoist. Whenever the hoist is used it is important to have a firm grip on the chain or have the chain properly locked into the retaining bracket. The door is not counter-balanced, and doing otherwise may allow the door to unroll rapidly causing damage to the assembly. There are no physical stops at the full-down position (yet).**

Remove the safety/shipping vinyl strapping from the door roll. Carefully unhook the hoist chain from the bracket and use the hoist feature to lower and raise the door. As required, guide the bottom of the vinyl door into the extrusion. Make sure that the lower roller on the door enters the outermost channel (with the radius profile) of the vertical extrusions. Observe the door action and look for any binds or interferences that hinder the operation of

the door. Resolve any issues before proceeding on to the next steps. Manually raise and lower the door a number of times. This will allow the wrinkles to come out of the vinyl material and ensure that the door is properly rolled on the tube.

Lower the door until the bottom edge of the vinyl door contacts the floor and compresses a couple of inches.. Securely lock the chain into the keeper. Slide the Stop Bumper on the front section of chain all the way up the chain until it contacts the stop bracket. Install a hitch pin as shown in the following photo (Photo 14). This bumper will control the “Fully Closed” position of the door.



**Photo #14**  
(Stop Bumper Installation)

Using the chain hoist, raise the lower the door a couple of times checking for binds, alignment problems, and the positions of the Fully Open and Fully Closed stop bumpers. The “Closed Position” can be adjusted by moving the Hitch Pin and Stop Bumper “up or down” on the chain as required. The “Open Position” can be adjusted in a similar manner, but never adjust the “Open Position” so that the bottom roller of the door is above the top of the vertical extrusion.

Re-secure the corner screws on the “Box Valence” (upper box section) of the door.

The assembly, installation, and set-up of your NoPest Door is now complete and it is ready for typical operation. It is a virtually maintenance free unit and should give you years of reliable service.

We want to thank you again for your business and the opportunity to partner with your firm on this project. Please don't hesitate to contact us if you have any questions regarding these instructions or encounter any problems with the installation or performance of your door.