



Pioneer Industrial Doors
PO Box 338 • Spring Hill, TN 37174
Toll Free: 866.753.2655
Fax: 931.486.0316
www.pioneerindustrialdoor.com

Installation Instructions

RollRight 300RR II - 36 Vertical Vinyl Curtain Door

“Face Mount with ECB External Operator”

We have pre-assembled the roller, valence, and bracketry components for your Motorized Door. This should dramatically simplify the installation procedure. While the installation is very straightforward, please note the following details.

System Overview:

Your Pioneer Vinyl Vertical Curtain Door is a high quality, high performance flexible door system based on proven components and our many years of experience in the vinyl partition fabrication business. We are confident that it will bring you and/or your customers' years of reliable and trouble-free service.

Your specific system is a vinyl motorized roll-up curtain door with face-mount bracketry and an external operator. The “back-to-back” mounting dimension for your vertical extrusions will be the door opening width plus approximately 8” (eight inches). The vertical extrusions are cut to the same height as your stated door opening, which will place the entire motorized roll, upper bracketry, and valence box above the door header.

Unpacking and Inspection:

Please unpack your systems carefully and notify the factory immediately if there are any shortages or if any items have been damaged during transit. Your kit(s) should have all of the necessary hardware and components for a complete installation with the following exceptions (installer-provided hardware):

1. Mounting hardware for securing the custom extrusions, bracketry and external operator to the building fascia.
2. Hardware and conduit associated with the professional electrical installation of the 115VAC source power.

System Assembly:

Site Preparation:

It is imperative that the heavy duty bracketry and external operator for your door assembly is mounted to a flat and uniform surface. Mounting the door or operator to an uneven surface can cause the bracketry to bend and distort, causing improper door operation and premature failure.

Sections of vinyl stripping are in place to stop the vinyl door from unrolling during installation. DO NOT remove these straps until after the drive chain has been installed!

Lay the upper box section of your door on a flat surface and measure the “back-to-back” angle bracket dimension for your specific door as shown in the following photo (Photo 1). In this specific case the dimension is 106”.

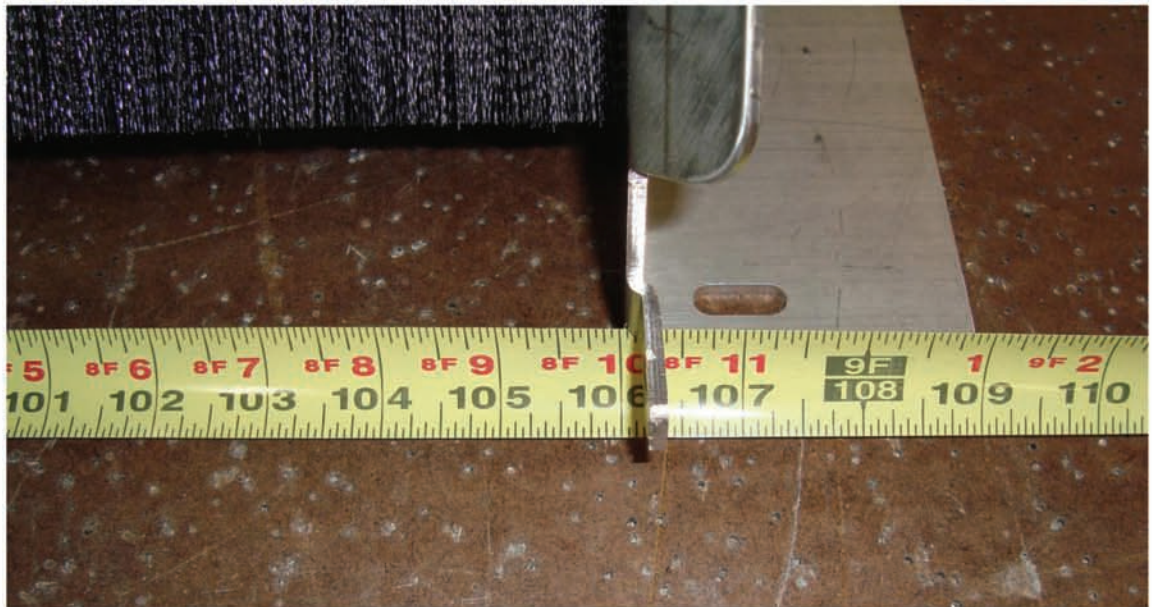

Photo #1

(Angle Bracket Back-to-Back Dimension)

Divide this number by 2 (53” in this specific case). This will be your “A” dimension.

Lay one of your custom vertical extrusions (side rails) on a flat surface and measure the overall length of the extrusion as shown in the following photo (Photo 2). In this specific case the dimension is 143.75” (143 ¾”).



Photo #2

(Extrusion Overall Length Dimension)

Add .25" ($\frac{1}{4}$ ") to this dimension (144" in this specific case). This will be your "B" dimension.

Make a mark on your building fascia "A" inches to the right from the top centerline of your door opening. This mark will correspond to the approximate edge location for your angle bracket. Repeat this process to the left of your opening centerline.

Make a horizontal line on your building fascia to the left and right of your opening at "B" inches from the ground surface. This line will correspond to the bottom edge of your angle brackets.

The angle brackets have a footprint of approximately 3" to each side of the "A" mark and 14" above the "B" line as shown in the following diagram (Diagram 1). Make sure that this area is smooth, flat, and even.

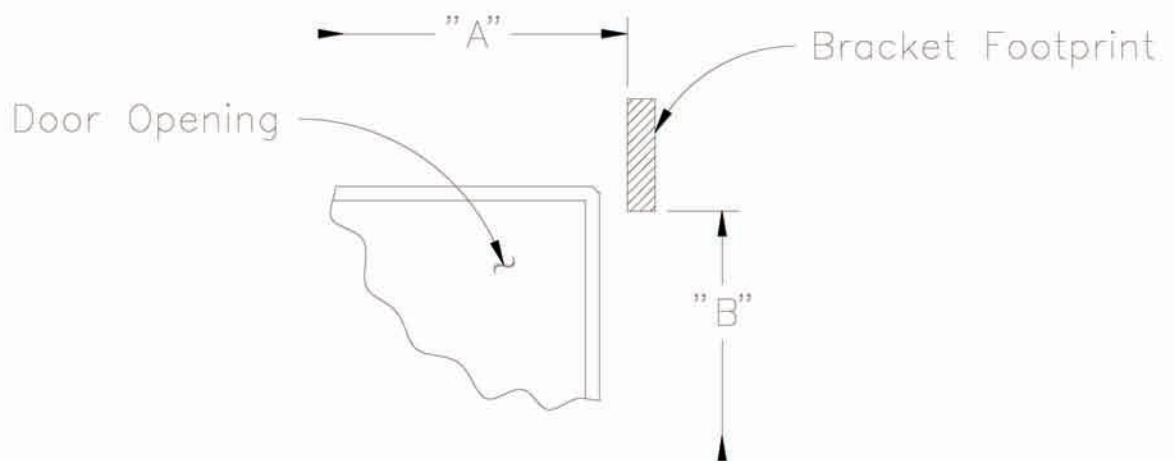

Diagram #1

(Angle Bracket Mounting Footprint)

Upper Box Mounting:

The Upper Box Section of your door is best installed by two people with individual ladders, one person and a scissors lift, or some other mechanism for raising and holding the box in position while it is being secured to the building fascia. The box section should not be bent or distorted while it is being mounted.

Raise the box section to the elevation of your opening header and use the “A” marks to center it about your door opening. Carefully adjust the elevation of the box ends until the bottoms of the angle brackets are in alignment with the “B” lines. Secure the left bracket to your building fascia using one fastener and washer as shown in the following photo (Photo 3). The specific fastener type will be a function of your building material, but each fastener should be at least ¼” in diameter and capable of handling at least 100lbs of shear and pull force.

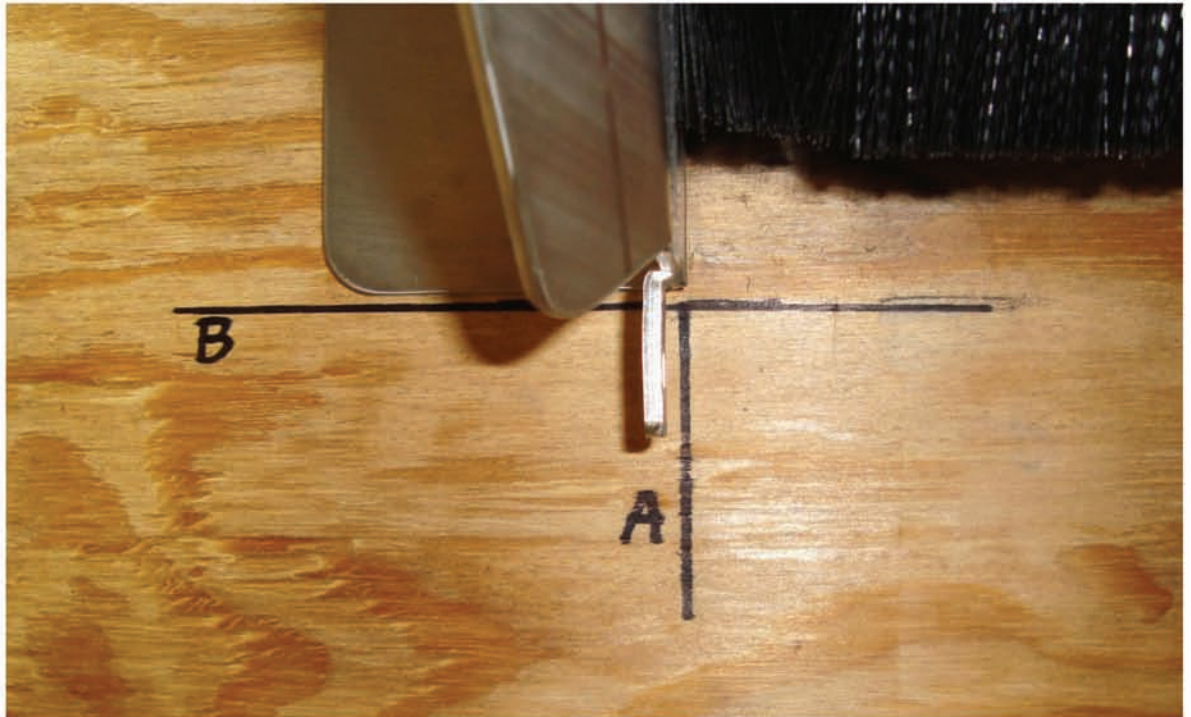

Photo #3

(Angle Bracket Alignment and Mounting)

Repeat this procedure on the right bracket. Double check the alignment of the door brackets and ensure that the box structure is not bent or distorted. Install the remaining four fasteners and washers in the angle brackets.

Vertical Extrusion Mounting:

The Custom Vertical Extrusions will first be secured to the angle brackets on the upper box section, and then secured to the building fascia via “J” brackets.

It is suggested that the galvanized brackets first be mounted to the extrusions. Typically one bracket is mounted approximately flush to the bottom end of the vertical extrusion and one bracket is mounted at the mid point. This can be accomplished by laying the extrusion

and the bracket on a flat surface, transferring at least one bracket hole location to the extrusion, drilling a .28" diameter hole in the extrusion, and securing the bracket to the extrusion with a 1/4-20 x .50 Pan Head Screw, 1/4" Flat Washer, and a 1/4-20 Hex Nut as shown in the following diagram (Diagram 2). Be very careful when drilling the Vertical Extrusions as to not damage the PVC seal strips and note the dimension for the proper location of the screw hole from the front "face" of the extrusion. There is a "drill start" groove inside of the extrusion which will help to locate the center line if you chose to drill the hole from the "inside" of the extrusion.

Alternately, for a "cleaner" installation or if there is insufficient door jamb for the standard mounting method, the "J bracket" can be flipped so that the mounting flange is "underneath" the extrusion (see Diagram 2). To do this, mount the Vertical Extrusion to the top bracketry per the instructions below, ensure the verticals are "plumb", mark the outside edge location of the vertical on the wall/jamb, remove the vertical, mount the J-bracket to the wall/jamb, reinstall the vertical and secure it to the J-bracket.

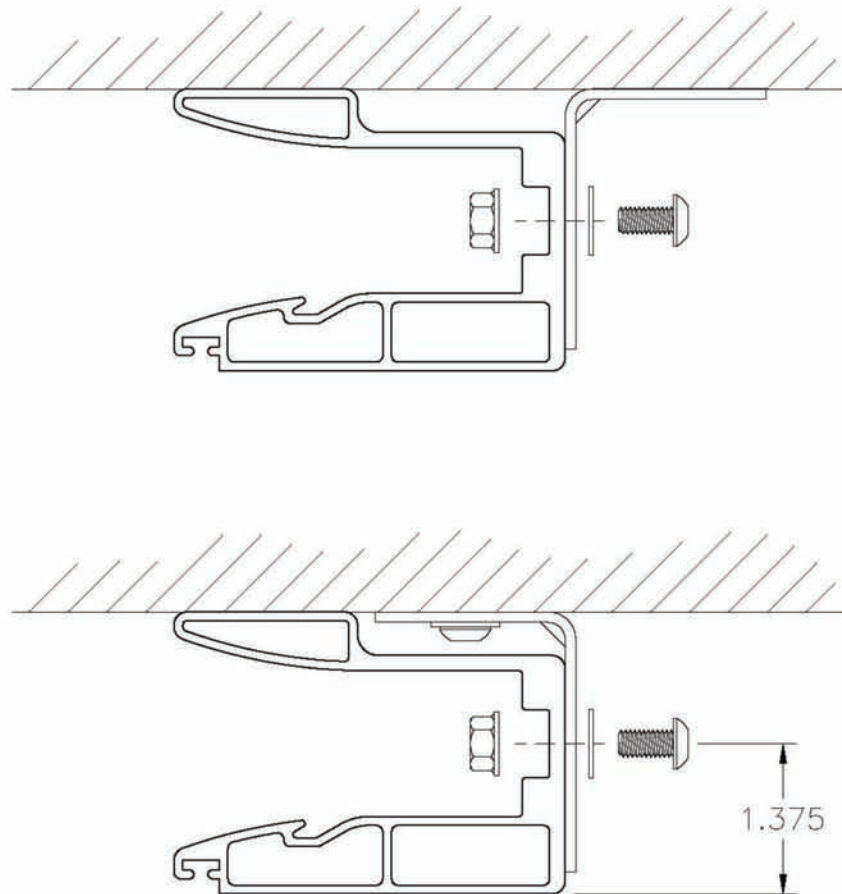

Diagram #2
(J-Bracket Alignment and Mounting)

Locate the left vertical extrusion (marked with a "TL") and orient it so that the extrusion is on the left side of your opening with the "TL" at the top and facing out. Secure the vertical extrusion to the angle bracket using the supplied 1/4-20 custom carriage bolt, nut and washer as shown in the following photo (Photo 4). Do not substitute any other fastener for the custom carriage bolt supplied.



Photo #4
(Vertical Extrusion Orientation and Mounting)

Use a Carpenters' level or a Plumb Bob to ensure that the left extrusion is completely vertical. Secure the "J" brackets to the building fascia using "best practices" as a function of the building material. The mounting should resemble the following photo (Photo 5):



Photo #5
("J" Bracket Mounting)

Orient the right vertical extrusion (marked with a "TR") so that it is on the right side of your opening with the "TR" at the top of the extrusion facing out. Secure the vertical extrusion to the angle bracket using the supplied ¼-20 custom carriage bolt, nut and washer.

Use a tape measure to ensure that the left and right vertical extrusions are parallel ($\pm \frac{1}{2}$ ") and secure the right extrusion "J" brackets to the building fascia using "best practices" as a function of the building material.

Safety Eye Installation:

Although it is an optional component, the reflective photo-eye is an important safety device and can help to avoid injury to personnel and damage to your motorized door system.

Select a suitable elevation for the installation of the photo-eye. Typically this is a few inches off of the floor level, but it can be installed at virtually any height.

Drill a 3/16" (.1875") hole at the desired elevation, one inch from the edge of the vertical extrusion opposite of the external operator. Only drill through the front wall of the extrusion. Secure a J-bracket to the front surface of the Vertical Extrusion using the supplied #14 x 1/2" sheet metal screw and washer as shown in the following diagram (Diagram 3):

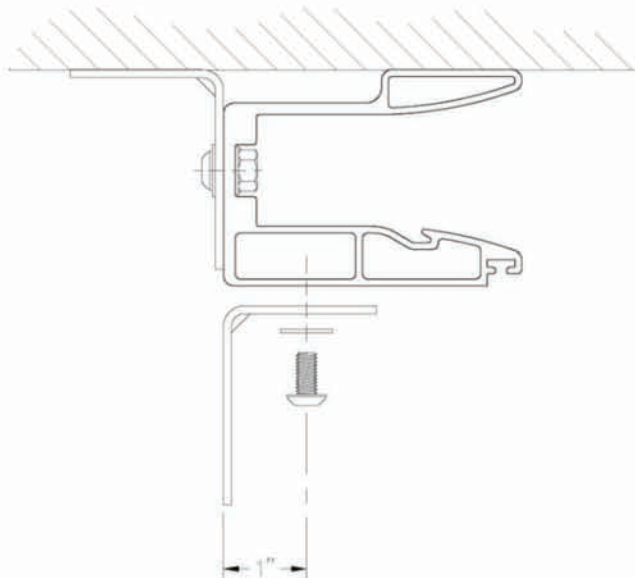

Diagram #3
(Reflector J-bracket Mounting)

Attach the photo-eye reflector to the J-bracket using the supplied hardware. Your installation should resemble the following photo (Photo 6):



Photo #6
(Reflector Mounting)

Per the following photo (Photo 7), attach the reflective head unit bracket to the opposite Vertical Extrusion. Set the height of the bracket to match the elevation of the reflector, transfer the slot locations to the Vertical Extrusion and drill two .28" diameter holes for the fasteners. Make sure the holes go through the center of the internal slot (1.375" from the front surface). Secure the bracket to the Vertical using the supplied 1/4-20 x .50 Pan Head Screws, 1/4" Flat Washers, and a 1/4-20 Hex Nuts. Assemble the head unit and protective cover to the bracket using the supplied hardware. Make sure that the head unit is aligned with the reflector.



Photo #7
(Head Unit Mounting)

External Operator Preparation:

Carefully remove the Opera External Operator from its shipping carton. Remove the fasteners that secure the operator to the backing plate (plywood) and inspect the unit for any damage. Open the accessory box and locate the 14 tooth output sprocket and 1/4" key (if not already installed). Install the sprocket on the operator output shaft as shown in the following photo (Photo 8) and tighten firmly. It is important to install the sprocket before the operator is mounted to your fascia.

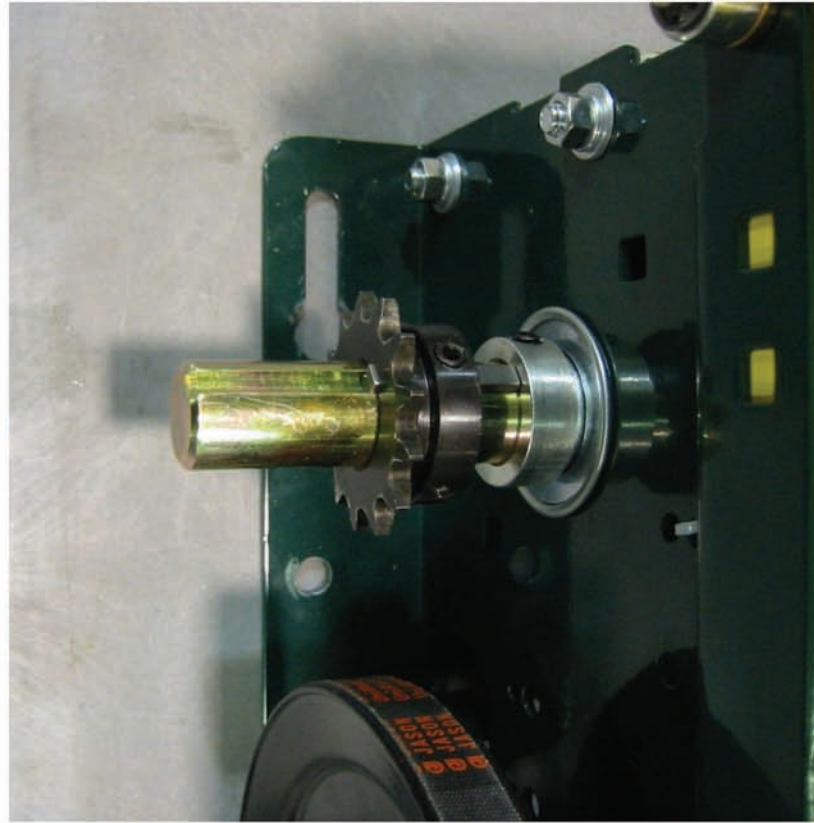

Photo #8
(Output Sprocket Installation)

External Operator Mounting:

The external operator (motor and reduction assembly) will be secured to your building fascia using 5/16" fasteners (bolts, lag screws, studs, etc.). Select fasteners that are not only right for your specific building material, but also that can endure repeated loosening and tightening. It may be necessary to loosen/tighten these fasteners a number of times in order to achieve proper initial chain tension and to later adjust for chain stretch and wear. The use of washers between the heads of the fasteners and the metal brackets on the operator is strongly recommended.

Tape the two pieces of the operator installation template together making sure to properly align the index mark (bottom of page #1, top of page #2). Cut along the indicated dotted lines and remove the section of the template that corresponds to the right mounting bracket of the upper box assembly.

Align the template with the right bracket on the upper box assembly and transfer the four hole locations for the 5/16" fasteners to your building fascia. Carefully lift the operator in place and secure it to your building using four 5/16" fasteners. Do not fully tighten the fasteners. Slide the operator "up" until the fasteners are at the bottoms of the mounting slots, and tighten the fasteners snugly enough to stop the operator from sliding back down. Your installation should resemble the following photo (Photo 9):



Photo #9
(External Operator Mounting)

Check the alignment of the two sprockets. They should be in direct vertical alignment. If not, loosen the set screws on either of the sprockets and adjust its position until it is in line with the other unit. See the following photo (Photo 10):

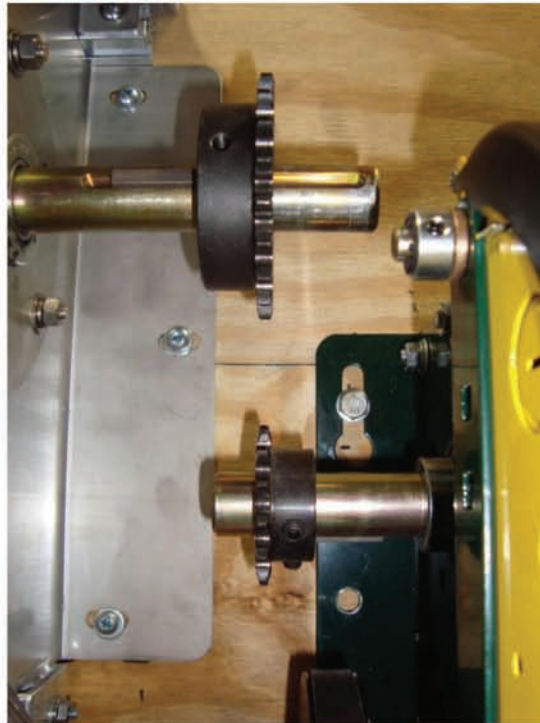

Photo #10
(Sprocket Alignment)

Locate the #41 chain and install it over the two sprockets. Secure the ends with the included master link as shown in the following photo (Photo 11):

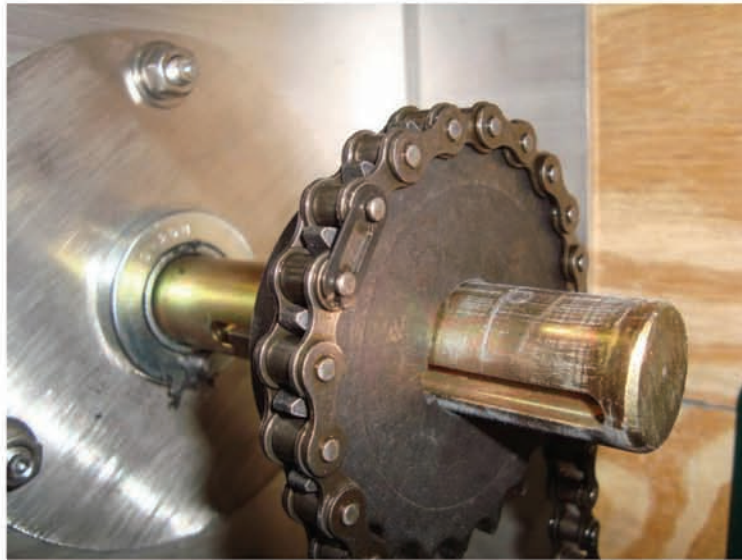

Photo #11
(Master Link Installation)

Loosen the four fasteners that secure the external operator to the building fascia and allow the weight of the operator to establish the tension in the chain. Make sure that the front and rear runs of the chain are “taught” (slightly rotate the roller tube by hand if necessary). Make sure that the sprockets are still in alignment and tighten the four fasteners. Your assembly should resemble the following photo (Photo 12):

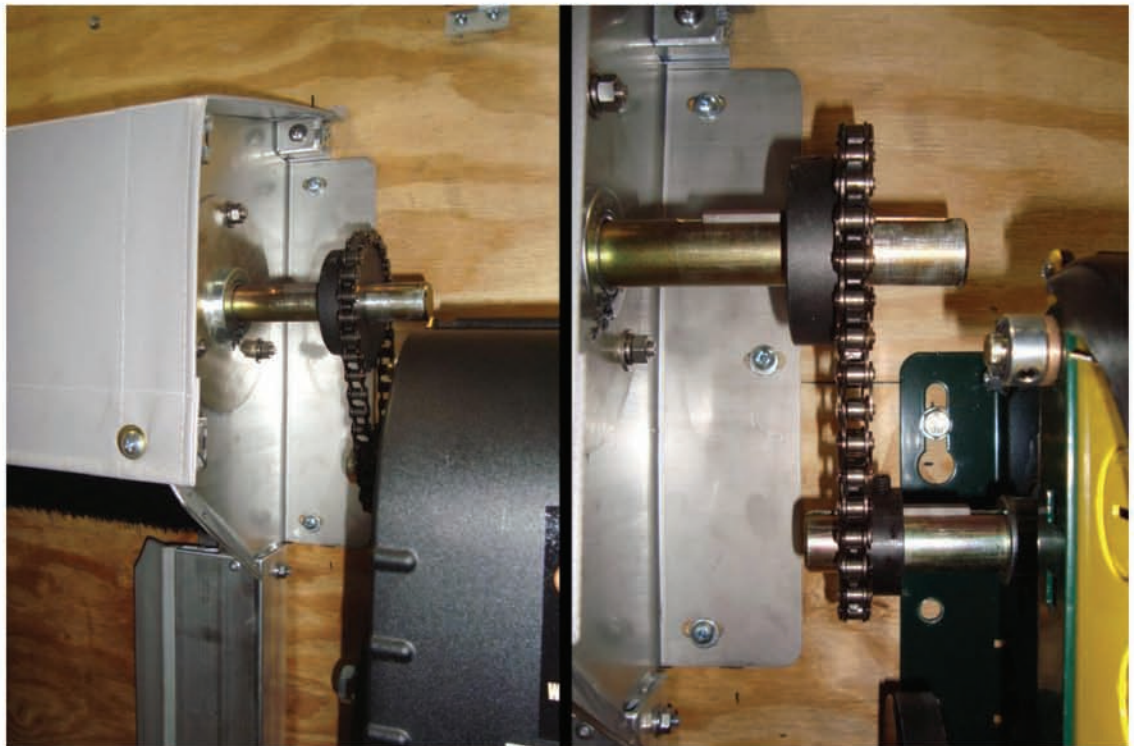

Photo #12
(Chain Installation)

Mount the Chain Bracket (Keeper) to the building wall directly below the release chain at a convenient elevation (usually about 4' from the floor). Route the release chain through the keyhole slot as shown in the following photo (Photo 13). The release chain can be trimmed to-length at any point below the bracket. We have also included a "T-handle" which can be optionally installed below the Chain Bracket. Please see the operator instruction manual for additional details.



Photo #13
(Chain Bracket)

Route the Hoist Chain over the Hoist Chain Sprocket as shown in the following photo (Photo 14):



Photo #14
(Hoist Chain Routing)

Join the free ends of the chain by opening one of the links. The chain may be shortened as required to avoid dragging on the ground. Secure both runs of chain to the bracket via routing it as shown in the following photo (Photo 15). The chain MUST be properly secured before going to the next assembly steps.



Photo #15
(Hoist Chain Locking)

Open the operator cover. The next steps will involve pre-setting the end stop (limit) nuts on the operator. To do this, press down on the locking bar as shown in the following photo (Photo 16) and rotate the metal notched nuts. When adjusting an end stop make sure that the other end stop does not accidentally rotate, and when you are done make sure that the notches on both nuts properly engage the locking lever bracket.

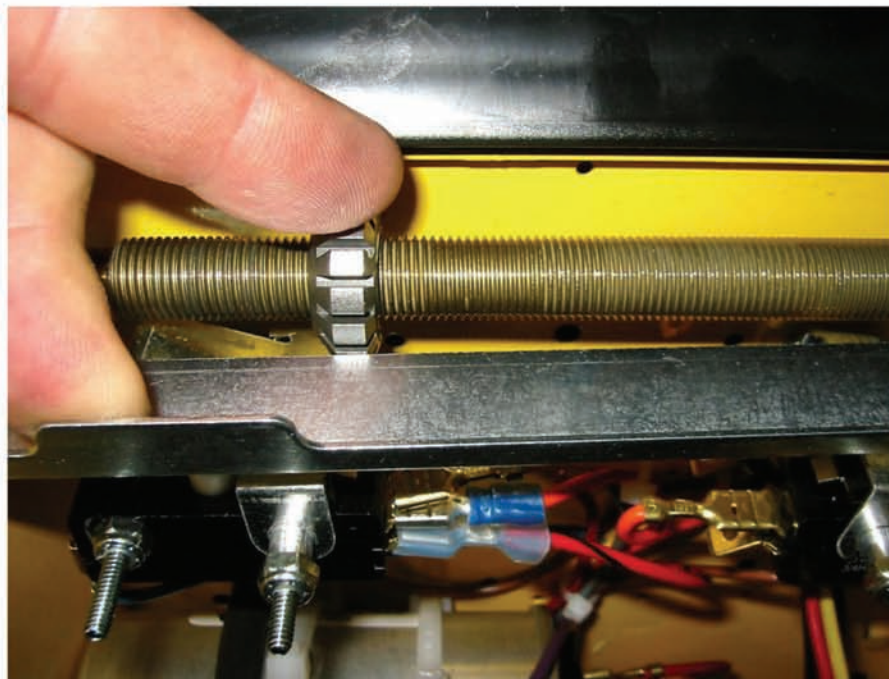

Photo #16
(End Stop Locking Bar)

Pre-set the “OPEN” (left) end stop so that the nut is flush with the left end of the threaded rod. Pre-set the “CLOSE” (right) end stop so that the nut is approximately 1.5” (one and a half inches) from the right end of the threaded rod. See the following photo (Photo 17):

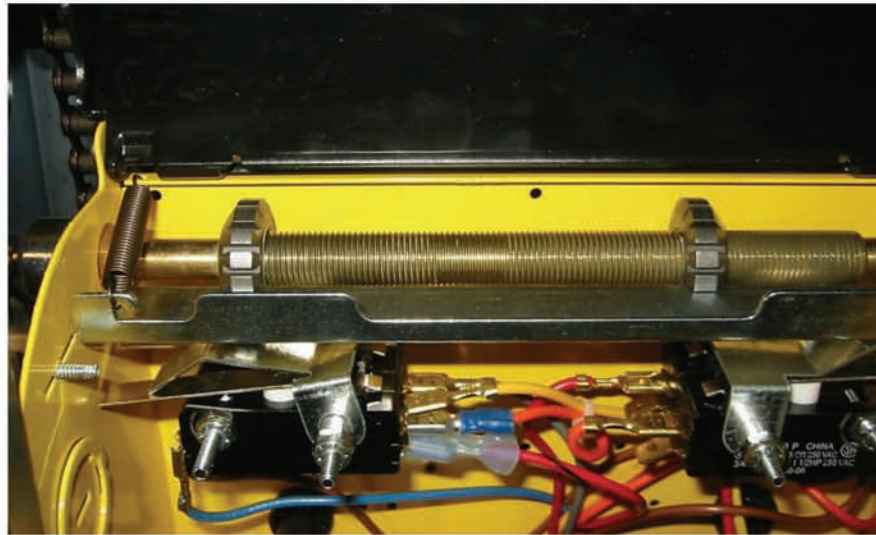

Photo #17
(End Stop Pre-Sets)

The next step involves releasing the operator brake and using the chain hoist. Whenever the operator brake is release it is important to have the hoist chain secured to the bracket or held firmly. The door is not counter-balanced, and doing otherwise may allow the door to unroll rapidly causing damage to the assembly.

Remove the safety/shipping vinyl strapping from the door roll. Pull down on the release chain until a firm resistance is felt. This will release the operator brake and engage the chain hoist. Use the keyhole feature in the chain bracket to hold the release chain in this position. Carefully unhook the hoist chain from the bracket and use the hoist feature to lower and raise the door. As required, guide the bottom of the vinyl door into the extrusion. Observe the door action and look for any binds or interferences that hinder the operation of the door. Resolve any issues before proceeding on to the next steps. Run the door up and down a number of times with the chain hoist. This will allow the vinyl door to “relax” and conform to the roll tube. Position the door to the approximate mid-point (halfway open) position, re-secure the hoist chain to the bracket and unlock the release chain.

Electrical Connections:

There are two independent and unique aspects of the wiring configuration for your Motorized Vertical Curtain Door. These are the 115VAC 60Hz power wiring and the low-voltage control wiring. While the low-voltage side of the control system can be configured and properly wired by anyone who has a rudimentary understanding of electrical circuitry, the power wiring should be performed by an electrical professional and done in such a manner to conform to all local and national wiring codes and regulations.

115VAC Power Wiring:

The external operator requires 115VAC, 60Hz with a current draw of 5A (1/2 HP PSC inductive motor). Make sure that the branch circuit and conductor size can support this load requirement. Low voltage can cause erratic behavior and operator overheating.

Locate the rotary selector switch on the printed circuit board and ensure that it is set to “C2” (position 0) as shown in the following photo (Photo 18):

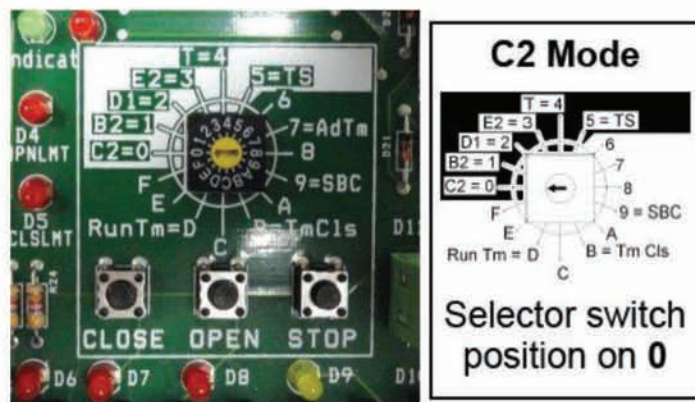

Photo #18
(C2 Control Selection)

Power and ground are connected to the operator as shown in the following photo (Photo 19):



Photo #19
(Power Connections)

Control Connections:

The operator supports NEMA-1 and NEMA-4 3-button control stations with N/O “Open” and “Close” buttons. The “Stop” buttons must be N/C. The low-voltage control connections for the primary (first) station should be made with the 4-conductor “Thermo Wire” that was included with your kit. Although the color codes are arbitrary, Pioneer has selected the following standard:

Green	-	(8) COM
Red	-	(9) STOP
Blue	-	(7) OPEN (UP)
White	-	(6) CLOSE (DOWN)

Single-station control installations are performed by simply running the control wiring between the control station and the operator, and attaching the appropriate wires to the screw terminals as indicated in the following photos (Photos 20 and 21):

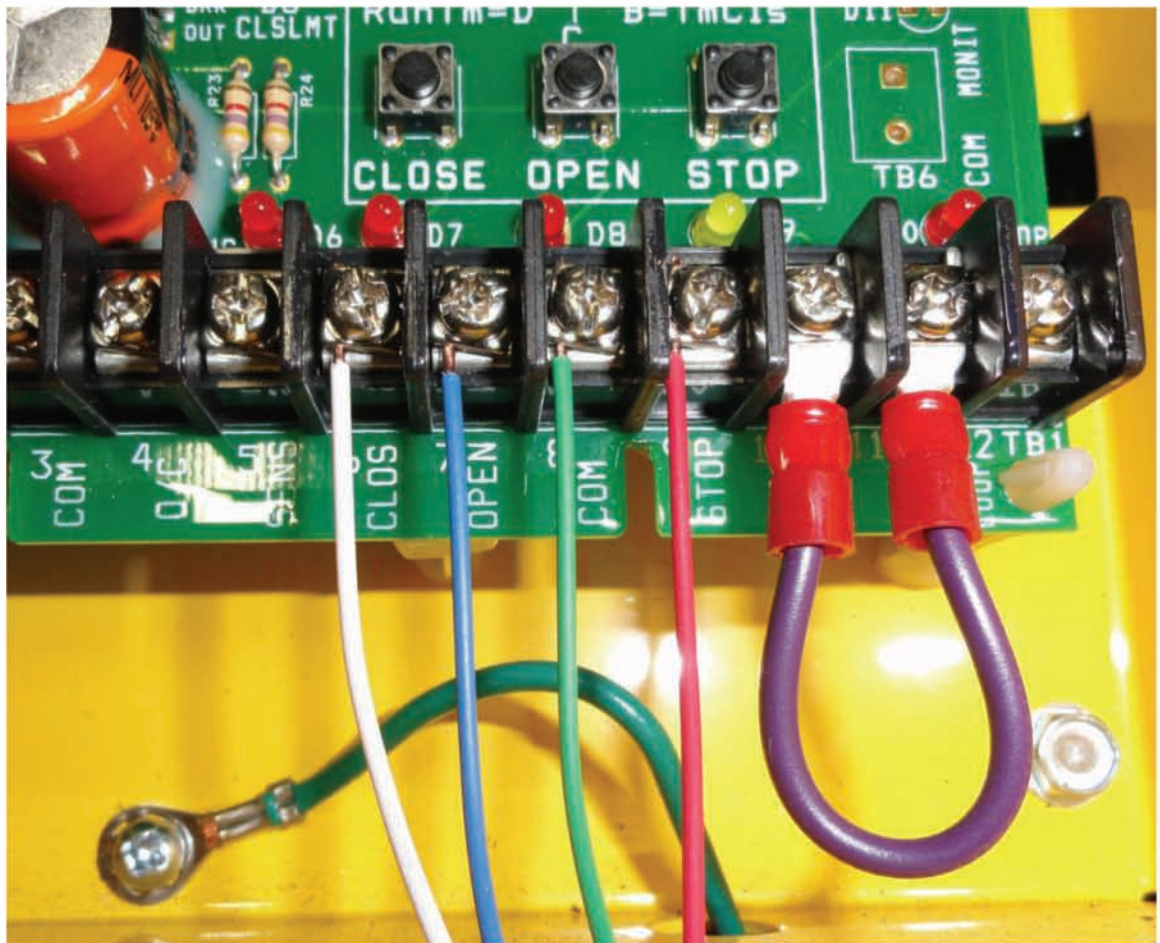

Photo #20
(Operator Control Connections)

Additional NEMA-1 and NEMA-4 control stations (along with PullCord and RF Interfaces) can be added to the Pioneer operator. Please see the “Addendum” at the end of these assembly instructions for further wiring information.

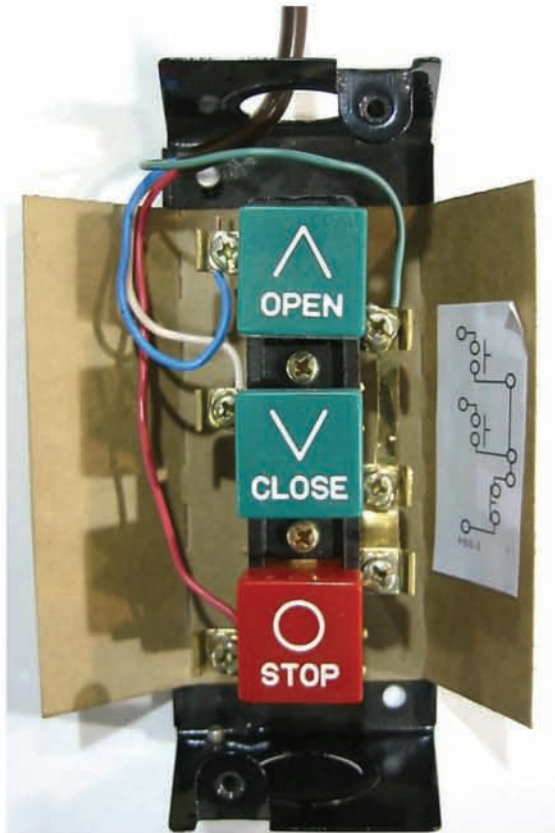

Photo #21
(NEMA 1 Connections)

Photo-Eye:

The OEM cable for the photo-eye will not be long enough to reach the external operator in many installations. We have included a junction box, cover, glands, wire nuts, and some additional 4-conductor wire so that an extension can easily be fabricated.

The wiring convention for the photo-eye is as follows:

Brown	-	(1) 24Vac (Power)
Blue	-	(2) 24Vac (Power)
Black	-	(5) SENS
Orange	-	(3) COM
White	-	Not Used

Remove the protective rubber cap from the photo-eye head unit, and open the clear plastic door. Set the slide switch to “Dark Operation” (DK) by sliding it to the “left”.

Enable power to the operator and observe the LEDs on the photo-eye head unit. The RED and YELLOW LEDs should be illuminated. When the cross-beam is broken (blocked) the RED LED should go out and the GREEN LED should illuminate. Adjust the mechanical alignment of the head unit and the sensitivity of the circuit to ensure reliable and robust operation. Close the clear plastic door and re-install the protective rubber cap.



Photo #22
(Photo-eye settings)

Setup and Operation:

After the power wiring has been installed (and power has been enabled to the unit) it will be necessary to set the curtain door end-stop positions. Care should be exercised during these operations to avoid damage to the assembly and ensure a long service life of the unit. The door will open with only a momentary pressing of the “Open” button, but it will be necessary to press and hold the “Close” button in order to get the door to move down. This functionality will be changed when you do the final programming.

NOTE: When the door is closed from the fully open position the operator will “pulse” a number of times before accelerating to full speed. This is the unique “Soft Start” feature and is not a defect in the operator or controls.

Setting End Stop Positions:

If not already done, use the chain hoist to move the door to the approximate “mid” position (half-way open/closed). Release the brake/hoist actuation chain and make sure that it does not get “hung up” on the chain bracket (keeper). The chain should be in the large hole of the “keyhole” slot.

With your fingers clear of the operator, press (and hold) the “Close” button on the control station or the operator printed circuit board. The door should move down a few feet and then stop. If the door does not stop, release the “Close” button before the bottom of the door touches the floor. Press the “Open” button. The door should move up a few feet and stop. If the door does not stop, press the “Stop” button before the door reaches the fully open position. Double-check for any binds in the door operation and resolve those issues before proceeding.

Adjust the positions of the end stop nuts in order to tune the door open and closed position. It is easiest to rotate the Open nut when the door is at the closed limit, and rotate the Close nut when the door is at the open limit. Use the control station or operator buttons to cycle back and forth between the two stops as you incrementally adjust the nut positions. As you approach the final settings it is wise to only adjust the nuts a “notch” or two at a time. Overshooting the desired open and close positions can cause damage to the door assembly.

The Open position should be set so that the bottom of the door “chain pocket” is flush with the bottom of the brush seal as shown in the following photo (Photo 23).. **DO NOT** set the upper stop position more than 2” above this point. Setting the Open position below this point will not hamper the function of the door, but the “auto reset” feature may not work reliably. Setting the Open position more than 2” above flush may cause reliability problems.



Photo #23
(Open Position)

This Closed position should be set so that the bottom chain pocket comes in contact with the floor along the entire width of the door and compresses slightly (~1”) per the following photo (Photo 24). Do not set the door for more compression than that.



Photo #24
(Closed Position)

Slip Clutch Setup:

The operator slip clutch is an important safety component designed to protect the door and personnel. It should be adjusted carefully and properly.

Position the door at the fully closed (down) position. Using two wrenches hold the adjustment nut on the operator slip clutch and loosen the lock nut per the following photo (Photo 25):

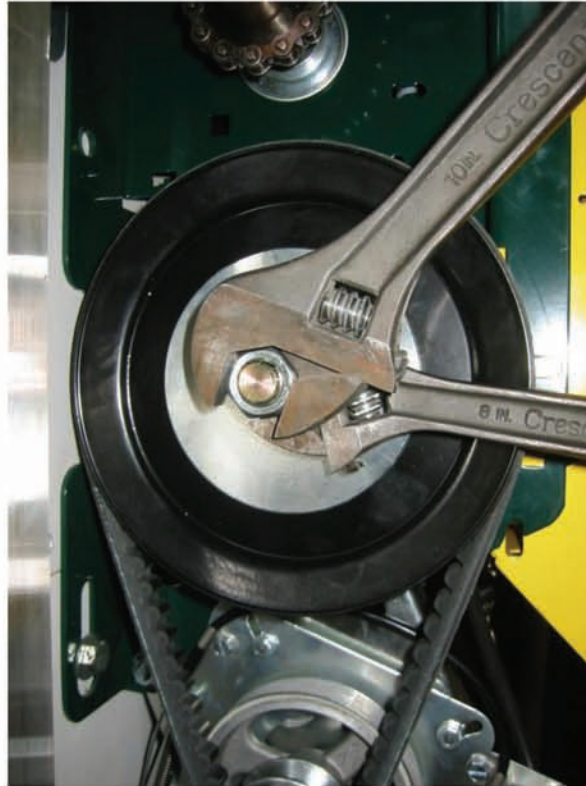

Photo #25
(Loosening Clutch Nuts)

Position the lock nut until it is approximately flush with the end of the shaft, and then loosen the adjustment nut until it is almost touching the lock nut.

Press the Open button on the control station. The large pulley on the operator should spin but the door should not move upward. If the door does move, reset the door to the closed position and loosen the nut(s) an additional turn. Repeat until the door does not move.

Allow the operator to run (with the clutch slipping) for approximately 20 seconds. This will help to “break in” the clutch. Press the Stop button.

Tighten the adjustment nut by one turn and press the Open button on the operator. Note the action of the door and press Stop. If the door did not move, tighten the nut an additional turn and repeat the above procedure. Continue repeating the procedure until the door moves upward when you press the Open button. Tighten the nut an additional $\frac{1}{2}$ turn and then lock the adjustment in place with the lock nut. Press the Open button and observe the operation of the door. The door should go all the way to the full Open position without any clutch slipping. If it does not, tighten the nut an additional $\frac{1}{2}$ turn.

Final Programming:

Fully close the door.

All programming changes on the operator must be made with the door in the fully closed position! Verify that the door is fully closed and that the close LED is illuminated.

The Maximum Run Timer (MRT) helps to protect the door and operator from damage should there be a bind or other problem. It does this by limiting the amount of time that the operator will run continuously. To set the time, position the rotary switch on the printed circuit board to the “D” (Run Tm) position as shown in the following photo (Photo 26):

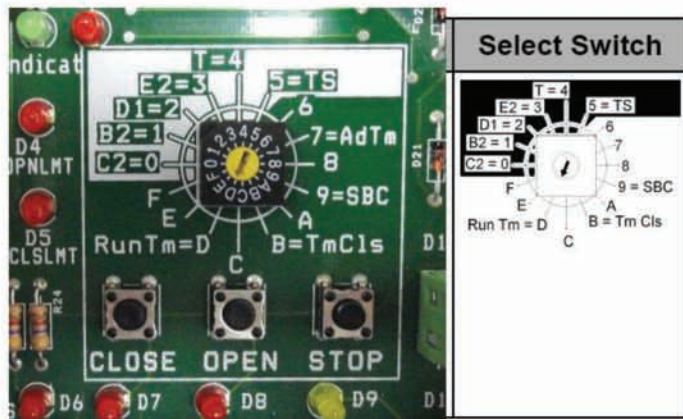

Photo #26
(MRT Control Selection)

Press the “Open” button and allow the door to reach the fully opened position. The MRT is now set. Immediately proceed to the next step.

Convert the operator from “Constant Pressure to Close” (C2) configuration to “Momentary Pressure to Close” (B2) by setting the rotary switch on the printed circuit board to the “1” position as shown in the following photo (Photo 27):

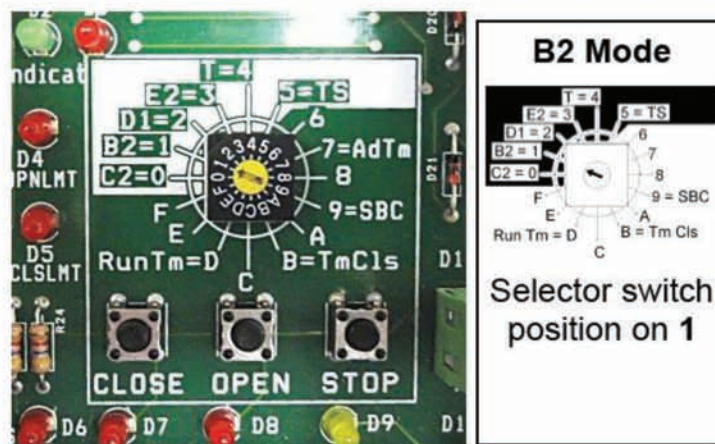

Photo #27
(B2 Control Selection)

The assembly, installation, and set-up of your Pioneer Motorized Curtain Door is now complete and it is ready for typical operation. Re-secure the corner screws on the “Box Valence” of the door and install the cover on the operator. It is virtually a maintenance free unit and should give you years of reliable service.

Operational Note: Larger door are equipped with an internal torsion spring counterbalance system. These doors can be identified by a “hitch pin” and tag installed on the non-operator end of the roll-tube center shaft. This pin is to remain installed during the normal operation of the door. It should only be removed for maintenance/service purposes, and ONLY when the door is in the fully open position. Removing the pin when the door is closed or partially closed may cause damage to the system and personal injury.

We want to thank you again for your business and the opportunity to partner with your firm on this project. Please don't hesitate to contact us if you have any questions regarding these instructions or encounter any problems with the installation or performance of your door.

Addendum

Using the built-in Auto-Close Timer (TTC):

The Auto-Close Timer (Timer to Close) will automatically close the door from the fully open position (only) after a preset amount of time has expired. To program the delay (dwell) time (the factory default is 5 seconds), perform the following operations:

Fully close the door and verify that the Close LED is illuminated.

Set the rotary switch on the printed circuit board to the “B” (Tm Cls) position as shown in the following photo (Photo 28):

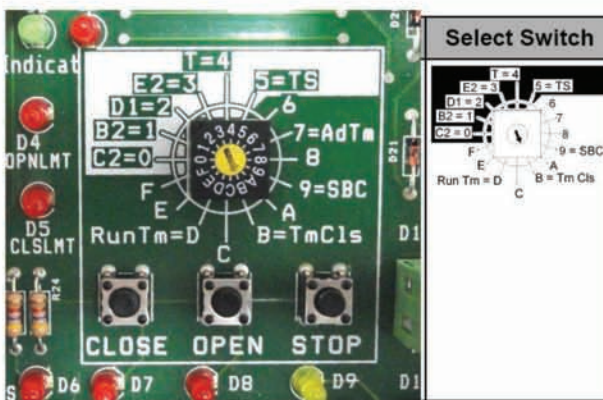

Photo #28

(Tm Cls Control Selection)

Press the “Stop” button to reset the delay time to 0 (zero) seconds.

Every press of the “Open” button will add 15 (fifteen) seconds to the delay and every press of the “Close” button will add 1 (one) second to the total time.

When the time delay has been set, enable the TTC mode by setting the rotary switch on the printed circuit board to the “5” (TS) position as shown in the following photo (Photo 29):

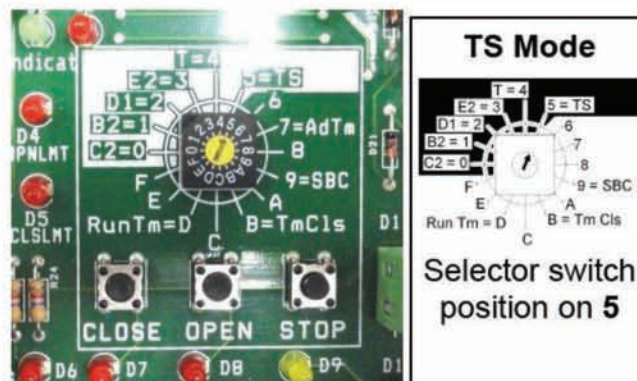

Photo #29

(TS Control Selection)

The door will now operate in TTC (Auto-Close Timer) mode.

To disable the TTC mode (without altering the programmed delay time), fully close the door and set the rotary switch on the printed circuit board to the “1” (B2) position. The TTC mode can be re-enabled by setting the rotary switch back to the “5” (TS) position when the door is fully closed.

To suspend the TTC **FOR ONE CYCLE ONLY**, press the “Stop” button 3 times and then the “Close” button 3 times while the door is in the fully closed position.

Installing the RF Receiver (Miller):

The Miller RF Transmitter/Receiver can be used in conjunction with NEMA-1, NEMA-4, PullCord, Single Button, and any other operator stations.

The wires from the RF Receiver are attached to the 24VAC, CONTACT, and GND terminals on the side of the external operator. Locate the receiver in a suitable location where the wires will reach and secure it to the building or operator. Carefully route the wires from the receiver to the terminals on the operator. Use tie-wraps or other means to ensure that the wires will not get caught or pinched in the operator mechanisms.

Install both the white and black wires on the GND terminal. The yellow wire will be attached to CONTACT and the red wire goes to 24VAC. The orange wire is not used. Your wiring should resemble the following photo (Photo 30):

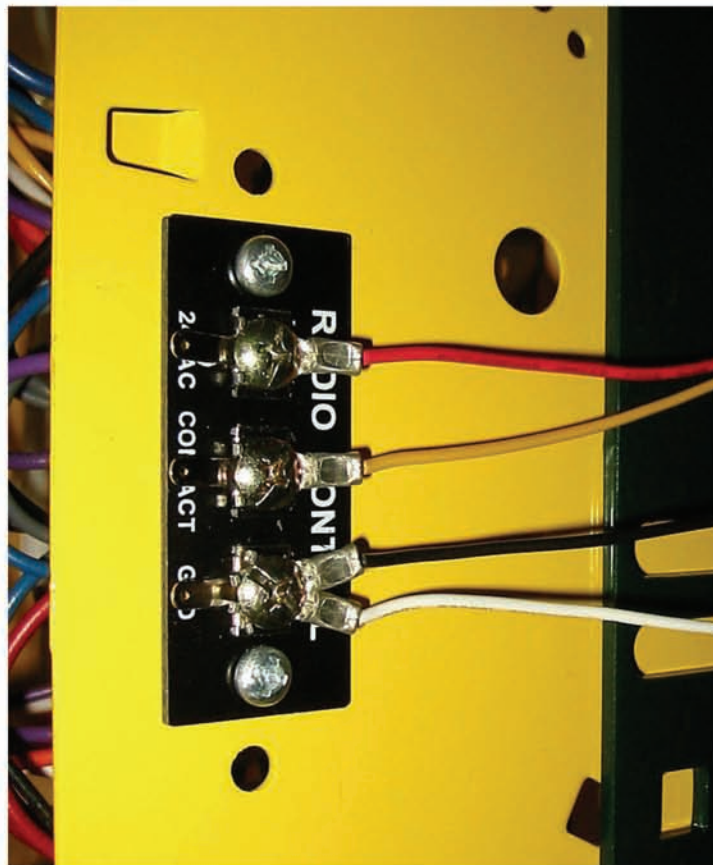

Photo #30
(RF Receiver Wiring)

Per the included instructions, set the DIP switch codes on the transmitter and receiver to the same value. Your RF system should now be ready to use.

Door hardware, the operator, and building configurations can substantially reduce the range of your RF system. If your performance is substandard, try repositioning the green antennae wire until you get optimal performance. If good performance cannot be achieved, an external co-ax antennae can be added to your system. Please contact your local dealer or the Pioneer factory.

Installing the RF Receiver (Multi-Code):

The Multi-Code RF Transmitter/Receiver can be used in conjunction with NEMA-1, NEMA-4, PullCord, Single Button, and any other operator stations.

The wires from the RF Receiver are attached to the 24VAC, CONTACT, and GND terminals on the side of the external operator. Locate the receiver in a suitable location where the wires will reach and secure it to the building or operator. Carefully route the wires from the receiver to the terminals on the operator. Use tie-wraps or other means to ensure that the wires will not get caught or pinched in the operator mechanisms.

Install one of the gray wires and the black wire on the GND terminal. The other gray wire will be attached to CONTACT and the red wire goes to 24VAC. Your wiring should resemble the following photo (Photo 31):

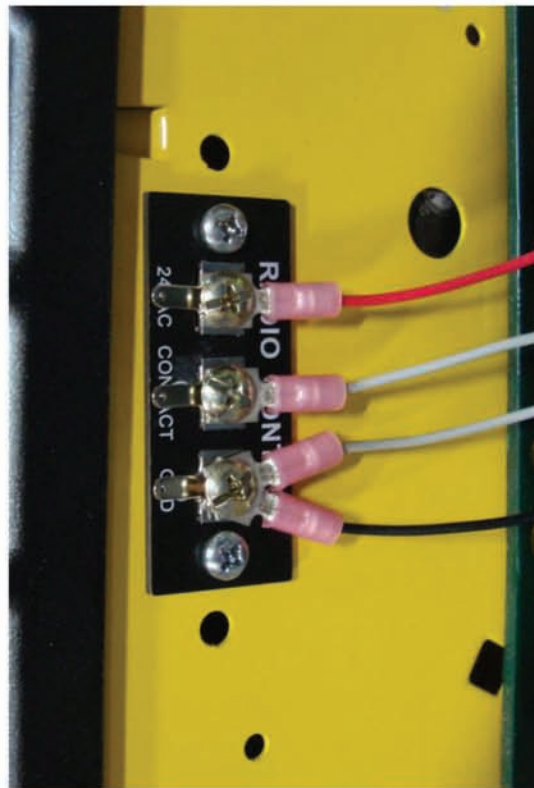

Photo #31
(RF Receiver Wiring)

Per the included instructions, set the DIP switch codes on the transmitter and receiver to the same value. Your RF system should now be ready to use.

Door hardware, the operator, and building configurations can substantially reduce the range of your RF system. If your performance is substandard, try repositioning the semi-flexible antennae until you get optimal performance. If good performance cannot be achieved, use the co-ax extension to relocate the antennae.

Installing the RF Receiver (Manaras):

The RF Transmitter/Receiver can be used in conjunction with NEMA-1, NEMA-4, PullCord, Single Button, and any other operator stations.

Assemble the terminal extension to the Manaras receiver as shown in the following photo (Photo 32):



Photo #32
(Manaras Receiver Preparation)

Open the cover of the operator and “swap” the positions of the purple and brown wires on the inside of the RF Interface Panel. The purple wire should be on the top terminal (24VAC) and the brown wire should be on the bottom terminal (GND) per the following photo (Photo 33):



Photo #33
(RF Receiver Wiring Swap)

Install the Manaras receiver on the operator as shown in the following photo (Photo 34). Slightly bending the mounting terminal tabs on the receiver will reduce the interference between the receiver case and the chain hoist pulley, but a slight rub is permissible and will not damage the unit.

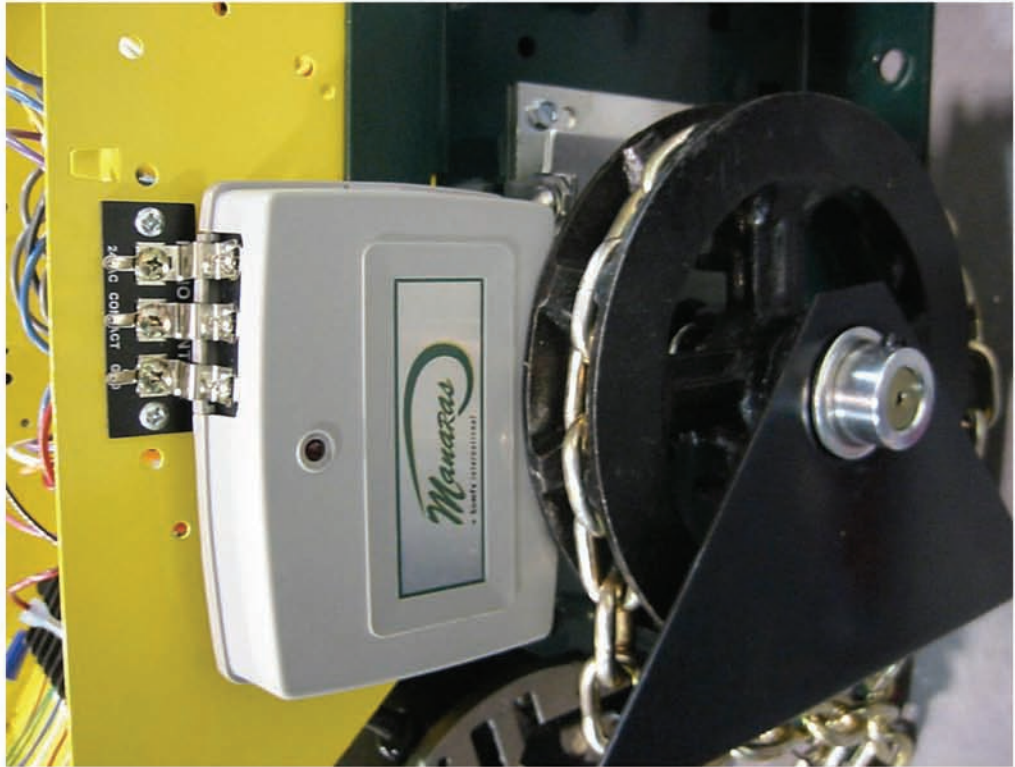

Photo #34
(Manaras Receiver Mounting)

Make sure that the antennae lead is routed in such a manner that it will not interfere with or get tangled in the workings of the operator.

Per the included instructions, set the DIP switch codes on the transmitter and receiver to the same value. Your RF system should now be ready to use and you can close the cover on the operator.

Door hardware, the operator, and building configurations can substantially reduce the range of your RF system. If your performance is substandard, try repositioning the antennae wire until you get optimal performance.

Adding Wired Control Stations:

Additional hard-wired control stations can be added to your external operator system. There is no limit to the number of stations that can be attached to the unit. The first (primary) control station is wired to the operator with 4-conductor wire while all subsequent stations require 5-conductor connections.

The “Open” and “Close” buttons on your control stations are N/O (Normally Open) and must be wired in PARALLEL. The “Stop” buttons are N/C (Normally Closed) and must be wired in SERIES (daisy chain).

NEMA-4:

Although the color codes are arbitrary, Pioneer has selected the following standard:

Green	-	Common
Red	-	Stop
Yellow	-	Stop Return
Blue	-	Open (UP)
White	-	Close (DOWN)

Remove the cover of the NEMA-4 station and note the location of the N/O and N/C terminals for each button. The N/O terminals are located closer to the base and are on the “right” side of the station. The N/C terminals are raised and are on the “left” side.

Use a short piece of green wire from the 5-conductor “Thermo Wire” and jumper between one of the N/O terminals on the Open button and one of the N/O terminals on the Close button. Also connect the free end of the green wire in the 5-conductor bundle to one of these terminals.

Connect the rest of the wires as shown in the following photo (Photo 35). Note that the yellow and red wires go to the N/C terminals on the Stop button.

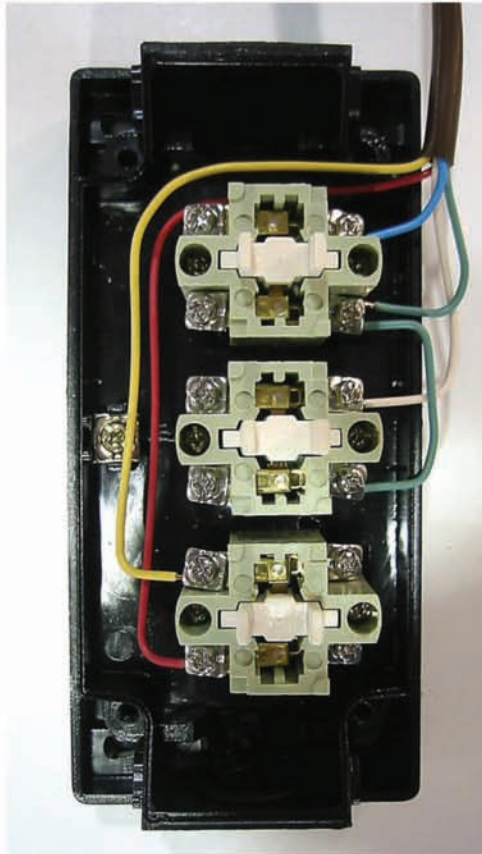

Photo #35
(NEMA-4 Station Wiring)

Route the cable through one of the station knockouts and carefully reinstall the cover. Make sure that the cover is installed properly and that the buttons work freely.

Locking NEMA-4:

Although the color codes are arbitrary, Pioneer has selected the following standard:

Green	-	Common
Red	-	Stop
Yellow	-	Stop Return
Blue	-	Open (UP)
White	-	Close (DOWN)

Remove the cover of the Locking NEMA-4 station and note the location of the N/O and N/C terminals for each button. The N/O terminals are located closer to the base and are on the “right” side of the station. The N/C terminals are raised and are on the “left” side.

Use a short piece of green wire from the 5-conductor “Thermo Wire” and jumper between one of the N/O terminals on the Open button and one of the N/O terminals on the Close button. Make another jumper between the Close button terminal and the top N/O terminal on the Lock. Connect the free end of the green wire in the 5-conductor bundle to the bottom N/O terminal on the Lock.

Connect the rest of the wires as shown in the following photo (Photo 36). Note that the yellow and red wires go to the N/C terminals on the Stop button.

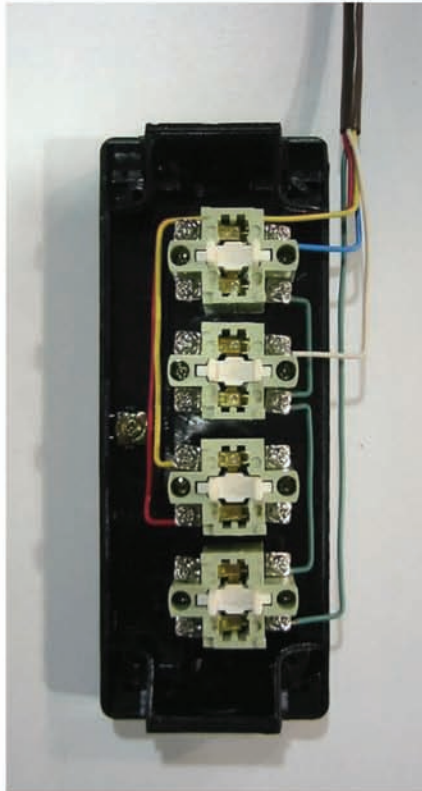

Photo #36
(Locking NEMA-4 Station Wiring)

Route the cable through one of the station knockouts and carefully reinstall the cover. Make sure that the cover is installed properly and that the buttons work freely.

NEMA-1:

Although the color codes are arbitrary, Pioneer has selected the following standard:

Green	-	Common
Red	-	Stop
Yellow	-	Stop Return
Blue	-	Open (UP)
White	-	Close (DOWN)

Remove the cover of the NEMA-1 station and cut the bonding strip between the Close and Stop button terminals. See the following photo (Photo 37):

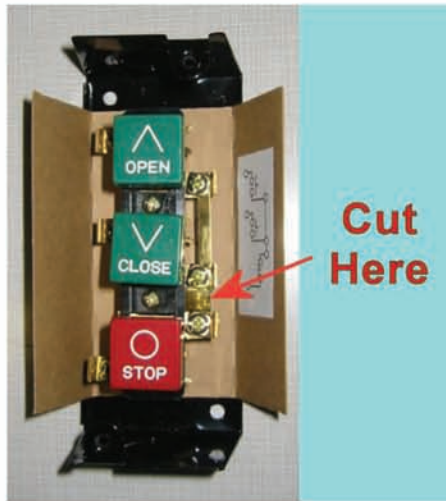

Photo #37
(NEMA-1 Station Cut Point)

Connect the wires as shown in the following photo (Photo 38). Note that the yellow and red wires go to the N/C terminals on the Stop button.

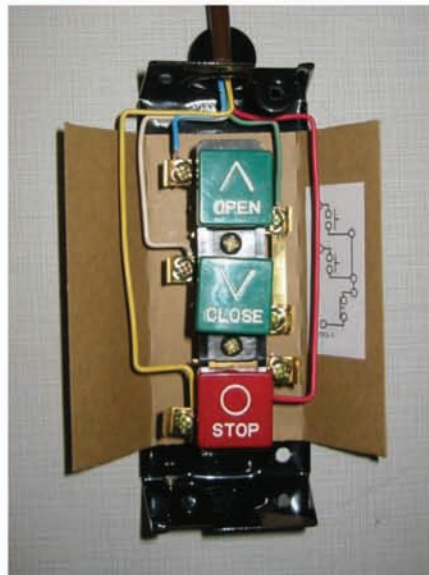

Photo #38
(NEMA-1 Station Wiring)

Route the cable through one of the station knockouts and carefully reinstall the cover. Make sure that the cover is installed properly and that the buttons work freely.

The other end of the 5-conductor “Thermo-Wire” is attached to the control terminals at the external operator. The blue (Open) wire connects to the same terminal as the blue wire from the primary control station (Terminal #7). The white (Close) wire will connect to Terminal #6, and the green wire (Common) connects to Terminal #8.

In order to connect the Stop buttons in series, disconnect the red wire from the primary control station from Terminal #9. Use the included blue wire nut to fasten it to the yellow wire of the station that you are adding (5-conductor bundle). Connect the red wire for the new station to Terminal #9. Your connections should resemble the following photo (Photo 39):

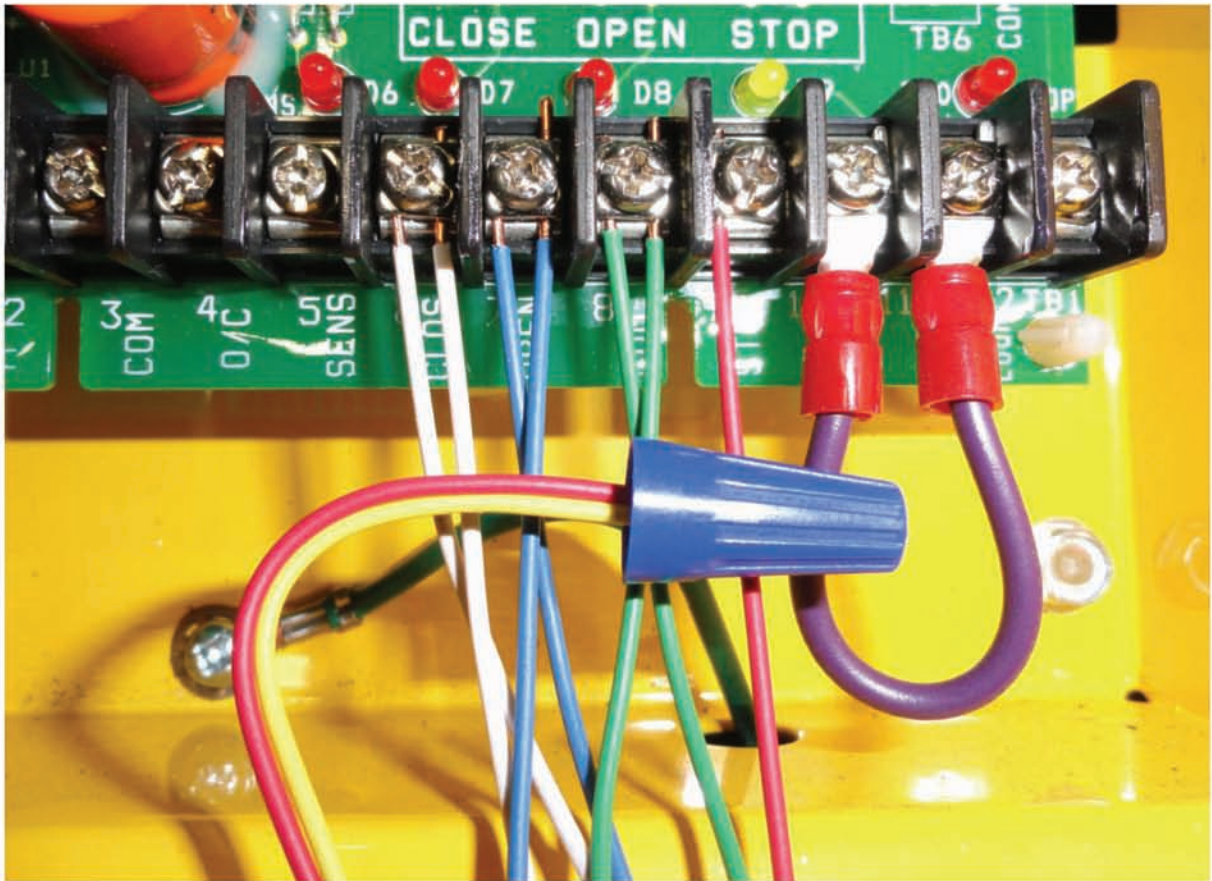

Photo #39
(Additional Station Operator Wiring)

The wiring for the additional control station is now complete. You can continue to add control stations by following this same procedure. Connect the blue, white, and green wires to the corresponding terminals in the operator. Disconnect the red wire from the previous station from the #9 Terminal, connect it to the yellow wire for the new station (wire nut), and connect the red wire for the new station to Terminal #9.

Adding PullCord or Single Button Control Stations:

The External Operator supports N/O (Normal Open) Pullcord Switches, N/O Single Button Control Stations, and any other N/O dry contact. All N/O switches should be wired in PARALLEL and the wiring junctions can be made either at the switches (daisy-chain) or at the External Operator (Home-Run). Switches should be connected using two-conductor wiring (supplied) and terminated at the External Operator at the #3 (COM) and #4 (O/C) terminals. Color codes are not important.

Switch Wiring:

Control wiring should be attached to the NEMA-4 Single Button Control Station at the lower two N/O terminals (#'s 13 & 14) as shown in the following photo (Photo 40):



Photo #40
(Single Button Station Wiring)

Control wiring should be attached to the Pullcord Switch Stations at the two N/O terminals as shown in the following photo (Photo 41):



Photo #41
(Pullcord Switch Station Wiring)